

We make
ordering easy
1-800-634-4885

CLUTCHES & PRESSURE PLATES

T.H.E. Company
offers five easy ways to pay



With Hy-Capacity
T.H.E. Quality
Shows!

FREIGHT VARIES
BY WEIGHT

Core Charges Apply



Allis Chalmers Clutch Application

Model	Size	S/N Etc	Style	Disc P/N	Disc Price	PPA P/N	PPA Price
B, C, CA	8 1/2"		Woven	D226730	\$72.97	D226262	\$98.65
			4 Pad	D226729HD	74.32	D226262	98.65
	9"		Woven	D232239	82.43	D247745	98.65
			4 Pad	D253187HD	98.65	D247745	98.65
WC, WF	10"		Woven	D226764	90.54	D230506	110.81
WD, WD45	10"	S/N WD45-99648 ↓	4 Pad	D256764HD	98.65	D230506	110.81
			Woven	D226764	90.54	D230506	110.81
	10"	S/N WD45-99648 ↑	4 Pad	D256764HD	98.65	D230506	110.81
			Woven	D226764	90.54	D230424	132.43
D 10	9"	S/N 3501 ↓	Woven	D232239	82.43	D247745	98.65
			4 Pad	D253187HD	98.65	D247745	98.65
	9"	EFF S/N 3501 ↑	Woven	D246660	109.46	D247745	98.65
			4 Pad	D256660HD	124.32	D247745	98.65
D12	9"	Prior S/N 3001	Woven	D232239	82.43	D247745	98.65
			4 Pad	D253187HD	98.65	D247745	98.65
	9"	S/N 3001	Woven	D246660	109.46	D247745	98.65
			4 Pad	D256660HD	124.32	D247745	98.65
D 14 D 15	9"		Woven	D232239	82.43	D247745	98.65
			4 Pad	D253187HD	98.65	D247745	98.65
D 17	11"	S/N 75000 ↓	Woven	D241255	98.65	D229344	101.35
			4 Pad	D247859	86.49	D229344	101.35
D17 Series IV	11"	S/N 75000 ↑ Both PPA and disc Must be Changed	6 Pad	D247859HD6	147.30	D229344	101.35
			Woven	D241255	98.65	D242572	136.49
			4 Pad	D247859	86.49	D242572	136.49
			6 Pad	D247859HD6	147.30	D242572	136.49
D 19	11"	Both PPA and Disc Must Be Changed	Woven	D241255	98.65	D241253	113.51
			4 Pad	D247859	86.49	D241253	113.51
D21	14"		6 Pad	D247859HD6	147.30	D241253	113.51
			8g. Pad	D254769HD6	174.32	D245984	213.51
170, 175	11"		8g. Pad	D254769HD8	229.73	D245984	213.51
			4 Pad	D247859	86.49	D242572	136.49
180, 185, 190	12"	Both PPA and Disc Must Be Changed	6 Pad	D247859HD6	147.30	D242572	136.49
			4 Pad	D247071	90.54	D280462	94.59
190 XT, 200	12"		4lg. Pad	D247071HD4	116.22	D280462	94.59
			6g. Pad	D247071HD6	147.30	D280462	94.59
210, 220	14"		4 Pad	D261029	102.70	D255689	94.59
			6 Pad	D261029HD6	160.81	D255689	94.59
7000	12"	S/N 8001 ↓ Heavy Duty Torque Limiter	6g. Pad	D254769HD6	174.32	D245984	213.51
			8g. Pad	D254769HD8	229.73	D245984	213.51
	12"	S/N 8001 ↑	4 Pad	D261029	102.70	D260462	145.95
			6 Pad	D261029HD6	160.81	D260462	145.95
7010 7020 7030	12"	Power Director Tractor	4 Pad	D269728	113.51		
			Heavy Duty 6 Pad	D269728HD6	154.05		
7040 7045 7050	12"	Power Shift Tractor	4 Pad	D268718	102.70	D269622	87.84
7060 7080 7580			Heavy Duty 6 Pad	D268718HD6	160.65	D269622	87.84
8010 8030 8050	12"	Power Shift Tractor	4 Pad	D268718	102.70	D269622	87.84
7010 8010 7020			Heavy Duty 6 Pad	D268718HD6	160.65	D269622	87.84
7060 (below 3893)	12"	Power Shift Tractor	4 Pad	D268718	102.70	D269622	87.84
8030 85050			Heavy Duty 6 Pad	D268718HD6	160.65	D269622	87.84
9435 9455	13"		Reman 6 Pad	W3154122	139.05	W3154165	286.20
9435 9455	13"		Heavy Duty 6 Pad	W3154122HD6	167.44	W3154165	286.20



Prices subject to change without notice. Call to verify pricing and availability.

Toll Free: 800-634-4885
Online at: www.the-co.com

HYDRAULIC/
DRIVETRAIN

We make
ordering easy
1-800-634-4885

CLUTCHES & PRESSURE PLATES

T.H.E. Company
offers five easy ways to pay



Case Clutch Application

Model	Size	Type	Disc #	Disc Price	PPA #	PPA Price
530	9 1/4"	10 Spl. Woven	A11079	97.30	A11002	159.50
	9 1/4"	17 Spl. Woven	A45794	109.46	A11002	159.50
	10"	10 Spl. Woven	A36145	129.73	A36567	112.16
	10"	17 Spl. Woven	A36147	112.16	A36567	112.16
	11"	17 Spl. Woven	A36414H	182.43	A36962	308.11
	11"	17 Spl. 4 Pad	A36142	118.92	A36962	308.11
	11"	Heavy Duty 17 Spl. 6 Pad	A36142HD6	154.05	A36962	308.11
	11"	21 Spl. Woven	A37568	98.65	A37566	112.16
	11"	21 Spl. 4 Pad	A51840	90.54	A39212	105.41
	11"	21 Spl. 6 Pad	A51840HD6	139.19	A39212	105.41
	700, 730, 770, 830, 870	12"	16 Spl. 4 Pad	A34277	89.90	357299
12"		Heavy Duty 16 Spl. 6 LG Pad	A34277HD6	139.19	357299	94.59
930 Comfort King Draft-O-Matic	15"	6 LG Pad	A32817HD6	154.05	A34459	264.86
970	14"	6 LG Pad	A58975HD6	167.57	A58974	560.25
1030	15"	S/N 8329959 ↓ 6 LG Pad	A32817HD6	154.05	A34459	264.86
	15"	6 LG Pad	A57425HD6	168.92	A34459	264.86
1070, 1090, 1170, 1175	15"	6 LG Pad	A57425HD6	168.92	A34459	264.86
1190	10"	Trans. Disc Woven	AK923374	77.03	AK918611	508.11
	10"	Trans. Disc 4 Pad	AK948966	105.41	AK918611	508.11
	10"	PTO Disc Woven	AK89322	77.03		
1470 Heavy Duty 1490, 1494	15"	9 Pad	A151116	209.46	A151115	351.63 15"
	12 Pad	A151116HD12	A151115	351.63		
	12"	Woven	AK956052 (4)	139.19	AK202291	563.51
	12"	6 Pad	AK956052HD6 (4)	160.81	AK954992	621.69
	12"	PTO Disc	AK947089	89.90		

Ford Clutch Applications

Model	Size	Type	Disc #	Disc Price	PPA #	PPA Price
2N, 8N, 9N, NAA 1953-57	9"	1-3/8" 10 SPLINE	WOVEN	FNA50A	66.89	F8N63S 77.03
NAA, 600, 700, 800, 900	10"	1" 15 SPLINE		FND50B	74.32	FND63A 79.73
8100 THRU TW-10	13"	1-3/4" 10 SPLINE	9 PAD	FD150C	173.33	FD863BA 139.19
8101 THRU TW-10			6 PAD	FD850AA	167.57	FD863BA 139.19
TW-15 THRU TW-35	14"	1-3/4" 10 SPLINE	8 PAD	FD850BB	145.33	FD863CA 221.62
	14"	1-3/4" 10 SPLINE	8 PAD HD	FD850BBHD8	229.73	FD863CA 221.62

***WE OFFER MANY MORE FORD CLUTCH & PPA APPLICATIONS - CALL FOR A PRICE QUOTE**

John Deere Clutch Application

Model	Size	Type	Disc #	Disc Price	PPA #	PPA Price
2010	10"	1 1/4" 10 Spl. Woven	R16930	\$ 94.59	R16053	\$ 89.90
	10"	Heavy Duty 1 1/4" 10 Spl. 4 Pads	R14612	98.65	R16053	89.90
	10"	Heavy Duty 1 1/4" 10 Spl. 6 Pads	R14612HD6	131.08	R16053	89.90
2510	11"	1" 16 Spl. Woven	R38498	90.54		
	11"	Heavy Duty 1" 16 Spl. 4 Pads	R38500	105.41		
	11"	Heavy Duty 1" 16 Spl. 6 Pads	R38500HD6	147.30		
2630	11"	1" 15 Spl. Woven	R63965	81.08	R100649	94.98
	11"	Heavy Duty 1" 15 Spl. 4 Pads	R63700	105.41	R100649	94.98
	11"	Heavy Duty 1" 15 Spl. 6 Pads	R63700HD6	137.84	R100649	102.70
2640	10"	1-3/8" 20 SPLINE	4 PAD	R24059	133.78	R63785 112.16
	11" DUAL	1-1/2" 15 SPLINE	WOVEN	R66923N	91.89	R27706 460.81
	11"	1" 15 SPLINE	WOVEN	R63965	81.08	R100649 102.70
	11"	1" 15 SPLINE	4 PAD	R63700	105.41	R100649 102.70
2750, 2940, 2950	12-5/8"	1-3/4" 27 SPLINE	5 PAD KIT	KIT		R39591 343.24
2750-55, 2950-55, 3150	12-7/8"	1-3/4" 27 SPLINE	5 PAD KIT	KIT		R64948 374.32
3055, 3155, 3255	12-7/8"	1-3/4" 27 SPLINE	6 PAD KIT	KIT		R67173 372.97
3010	12"	1 1/16" 16 Spl. Woven	R42125	87.84	R31310*	541.89
	12"	Heavy Duty 1 1/16" 16 Spl. 6 Lg. Pads	R42125HD6	132.43	R31310*	541.89
3020	12"	To S/N 097284 1" 16 Spl. Woven	R42125	87.84	R31310*	541.89
	12"	***-Heavy Duty 1" 16 Spl. 6 Lg. Pads	R42125HD6	132.43	R31310*	541.89
	12"	S/N 097285 and Up 1" 16 Spl. Woven	R42125	87.84	R31310*	541.89
	12"	***-Heavy Duty 1" 16 Spl. 6 Lg. Pads	R42125HD6	132.43	R31310*	541.89
4000	12"	1 1/4" 19 Spl. Woven	R42127	91.80	R41420*	590.54
	12"	Heavy Duty 1 1/4" 19 Spl. 6 Lg. Pads	R42127HD6	147.30		
4010	12"	1 1/4" 19 Spl. Woven	R42127	91.80	R41410*	564.86
	12"	Heavy Duty 1 1/4" 19 Spl. 5 Lg. Pads	R42127HD6	147.30		
4020	12"	To S/N 145659 1 1/4" 19 Spl. Woven	R42127	91.80	R41410*	564.86
	12"	***-Heavy Duty 1 1/4" 19 Spl. Lg. Pads	R42127HD6	147.30		
	12"	S/N 145660 - 223269 1 1/4" 19 Spl. Woven	R42127	91.80	R41420*	590.54
	12"	Heavy Duty 1 1/4" 19 Spl. 6 Lg. Pads	R42127HD6	147.30		
	12"	S/N 223270 & Up 1 1/4" 19 Spl. Woven	R42127	91.80	R41420*	590.54
	12"	***-Heavy Duty 1 1/4" 19 Spl. 6 Lg. Pads	R42127HD6	147.30		
4320	13 1/2"	1 1/4" 19 Spl. Woven	R49011	104.05	R43205*	639.19
	13"	Heavy Duty 1 1/4" 19 Spl. 8 Lg. Pads	R43203HD6	167.57		

HYDRAULIC/ 4-2
DRIVETRAIN

We make
ordering easy
1-800-634-4885

CLUTCHES & PRESSURE PLATES

T.H.E. Company
offers five easy ways to pay



4520	15"		1 3/8" 21 Spl. Woven	R43117	167.57	R43069	645.95
	15"	Heavy Duty	1 3/8" 21 6 Lg Pads	R43117HD6	209.46	R43069	645.95
	15"	Heavy Duty	1 3/8" 21 Spl. 6 Lg. Pads	R43117HD8	251.35	R43069	645.95
4620	15"		1 3/8" 21 Spl. Woven	R43117	167.57	R43069	645.95
	15"	Heavy Duty	1 3/8" 21 Spl. 6 Lg. Pads	R43117HD6	209.46	R43069	645.95
	15"	Heavy Duty	1 3/8" 21 Spl. 8 Lg Pads	R43117HD8	251.35	R43069	645.95
6030	13"	Double Disc	1 3/8" 21 Spl. 6 Lg. Pads	R64674	167.57	R87520	519.75
7520	13"	Double Disc	1 3/8" 21 Spl. 6 Lg. Pads	R64674	167.57	R87520	519.75
4030-4430 ↓ SN 47851	13"	PERMA CLUTCH	4 DISCS	KIT		R50156A	850.00
4430 ↑ SN 47852,	13"	PERMA CLUTCH	4 DISCS	KIT		R50156B	849.15
4040- 4440,4050 - 4450,4055 - 4455							
4640, 4650, 4755	13"	PERMA CLUTCH	7 DISC	KIT		R73144	1011.15

John Deere Combine Clutch Application

Model	Size	Type	Disc #	Disc Price	PPA #	PPA Price
3300	10"		1 3/8" 10 Spl. Woven	\$94.59	R65440	\$94.59
	10"	Heavy Duty	1 3/8" 10 Spl. 4 Pads	112.16	R65440	94.59
4400	10"	Prior to S/N 250501	1 3/8" 10 Spl. 4 Pads	112.16	R65440	94.59
	11"	EFF S/N 250501	1 3/8" 10 Spl. 5 Pads	105.30	R93292	93.15
6600, 7700	12"		1 1/4" 19 Spl. 4 Pads	97.95	R84956	97.20
	12"	Heavy Duty	1 1/4" 19 Spl. 5 Pads	104.70	R84956	97.20





International Clutch Application

Model	Size	S/N Etc.	Style	Disc P/N	Disc Price	PPA P/N	PPA Price
A, Super	9"		Woven	56631	\$ 78.38	375493	\$ 86.49
A, B, C, Super C	9"	Heavy Duty	4 Pad	384384	90.54	375493	86.49
H	10"		Woven	64772	77.03	52900	94.59
Super H	10 1/2"		Woven	358556	90.54	358555	83.78
M, MD	11"	FBK501 thru FBK294707	Woven	52848	54.73	52840	94.59
	11"	***Heavy Duty	6 Pad	52848HD6	139.19	52840	94.59
	12"	S/N FBK 294707 & Above	Woven	359168	90.54	357299	94.59
	12"	***Heavy Duty	6 LG Pad	359168HD6	147.30	357299	94.59
Super M	12"		Woven	359168	90.54	357299	94.59
Super MD	12"	Heavy Duty	6 LG Pad	359168HD6	147.30	357299	94.59
SMTA	12"		Woven	375564	101.35	359121	102.70
	12"		4 Pad	384395	98.65	359121	102.70
	12"	Heavy Duty	4 LG Pad	384395HD4	118.92	359121	102.70
	12"	Heavy Duty	6 LG Pad	384395HD6	139.19	359121	102.70
T.A. Clutch	7"		Metallic	375701	90.54	360215	77.03
100, 130, 140, 200	9"		Woven	56631	78.38	375493	86.49
450, 560	12"		Woven	375564	101.35	359121	102.70
	12"		4 Pad	384395	98.65	359121	102.70
400	12"	Heavy Duty	4 LG Pad	384395HD4	118.92	359121	102.70
	12"	Heavy Duty	6 LG Pad	384395HD6	139.19	359121	102.70
T.A. Clutch	7"		Metallic	375701	90.54	360215	77.03
384, 454	11"		4 Pad	530402	90.54	70716	91.89
	11"		6 Pad	70093	116.22	70716	91.89
	11"	Heavy Duty	6 Pad	830575HD6	139.19	830574	162.16
460, 504	10 1/2"		Woven	360488	94.59	360746	94.59
	10 1/2"		4 Pad	384633	90.54	360746	94.59
	10 1/2"	Heavy Duty	6 Pad	384633HD6	147.30	360746	94.59
T.A. Clutch	7"		Metallic	375701	90.54	360215	77.03
544	10 1/2"		4 Pad	384633	90.54	360746	94.59
	10 1/2"	Heavy Duty	6 Pad	384633HD6	147.30	360746	94.59
T.A. Clutch	7"		Metallic	375701	90.54	360215	77.03
574	11"		4 Pad	530402	90.54	70716	91.89
	11"		6 Pad	70093	116.22	70716	91.89
	11"	Heavy Duty	6 Pad	830575HD6	139.19	830574	162.16
706, 756	12"		4 Pad	384395	98.65	405300	109.46
766, 786, 806, 820	12"	Heavy Duty	4 LG Pad	384395HD4	118.92	405300	109.46
784, 884	12"	Heavy Duty	6 LG Pad	384395HD6	139.19	405300	109.46
784, 884	11"		6 Pad	70093	116.22	70716	91.89
	11"	Heavy Duty	6 Pad	830575HD6	139.19	830574	162.16
	12"	Conversion	6 Pad	85026	147.30	85025	137.84
	12"	Heavy Duty	6 LG Pad	85026HD6	174.32	85025	137.84
986	12"		6 Pad	104495	132.43	104496	110.81
	12"	Heavy Duty	6 LG Pad	384395HD6	139.19	104496	110.81
1066, 1086	14"		6 Pad	393117	139.19	390254	147.30
1206, 1256	14"	Heavy Duty	6 LG Pad	393117HD6	174.32	120181	154.05
	14"	Heavy Duty	8 LG Pad	67600HD8	237.84	67597	154.05
1456, 1466	14"		6 Pad	393117	139.19	67597	154.05
1468, 1486	14"	Heavy Duty	6 LG Pad	393117HD6	174.32	67597	154.05
	14"	Heavy Duty	8 LG Pad	67600HD8	237.84	67597	154.05
1566, 1568	14"		8 Pad	67736	147.30	67735	154.05

HYDRAULIC/
DRIVETRAIN

We make
ordering easy
1-800-634-4885
www.the-co.com

CLUTCHES & PRESSURE PLATES

T.H.E. Company
offers five easy ways to pay





International Combine Clutch Application

Model	Size	S/N Etc.	Style	Disc P/N	Disc Price	PPA P/N	PPA Price
715	10"	Wheel Drive	6 Pad	533703	\$ 102.60	533702	\$ 81.08
	10"	Separator Drive Unit (PPA & Disc)				161165	481.08
	10"	Separator Drive Disc Only	6 Pad	154759	137.70	154759	137.70
815, 915	12"	Separator Drive	4 Pad	167967	87.84	167968	591.89
	12"	***Heavy Duty	6 Pad	167967HD6	139.19	167968	591.89

White & Oliver Clutch Applications

Model	Size	S/N Etc.	Style	Disc P/N	Disc Price	PPA P/N	PPA Price
55, S55	10"	19 Spline PPA Hub	Woven	W100687	\$90.45	W870569	\$118.80
	10"	19 Spline PPA Hub-Heavy Duty	4 Pad	W3016668	105.30	W870569	118.80
	10"	24 Spline PPA Hub	Woven	W100687	90.45	W100691	97.30
	10"	24 Spline PPA Hub-Heavy Duty	4 Pad	W3016668	105.30	W100691	97.30

Oliver Clutch Application

Model	Size	S/N Etc.	Style	Disc P/N	Disc Price	PPA P/N	PPA Price
77, S77	9"	Tractors w/9 1/4" Clutch	Woven	W875572	\$ 66.22	W801569	\$ 93.15
	9"	Heavy Duty	4 Pad	W875572HD4	89.10	W163018	82.35
	10"	Tractors w/10" Clutch	Woven	W102093	90.54	W163018	82.35
88, S88	10"	Tractors w/10" Clutch	Woven	W102093	90.54	W163018	82.35
	11"	Tractors w/11" Clutch	Woven	W161153	82.35	W870880	98.65
	11"	Tractors w/11" Clutch-Heavy Duty	4 Pad	W161153HD4	112.05	W870880	98.65
	11"	Tractors w/11" Clutch-Heavy Duty	6 Pad	W161153HD6	160.65	W870880	98.65
550	10"	19 Spline PPA Hub	Woven	W100687	90.45	W870569	118.80
	10"	19 Spline PPA Hub-Heavy Duty	4 Pad	W3016668	105.30	W870569	118.80
	10"	24 Spline PPA Hub	Woven	W100687	90.45	W100691	97.30
	10"	24 Spline PPA Hub-Heavy Duty	4 Pad	W3016668	105.30	W100691	97.30
770	10"		Woven	W102093	90.54	W163018	82.35
880	11"		Woven	W161153	82.35	W870880	98.65
	11"	Heavy Duty	4 Pad	W161153HD4	112.05	W870880	98.65
	11"	Heavy Duty	6 Pad	W161153HD6	160.65	W870880	98.65
1550, 1555, 1600	11"		Woven	W161153	82.35	W155916	90.45
	11"	Heavy Duty	4 Pad	W161153HD4	112.05	W155916	90.45
	11"	Heavy Duty	6 Pad	W161153HD6	160.65	W155916	90.45
1650, 1655	12"	S/N 187586 ↓	Woven	W160971	98.55	W168823	98.55
	12"	All S/N	4 Pad	W163935	112.05	W168823	98.55
	12"	All S/N Heavy Duty	4 LG Pad	W163935HD4	132.30	W168823	98.55
	12"	Heavy Duty	6 LG Pad	W163935HD6	174.15	W168823	98.55
1750 Gas	12"	S/N 190958 thru 191355 and 191514 ↑	4 Pad	W165356	112.05	W168823	98.55
	12"	Heavy Duty	4 LG Pad	W165356HD4	125.55	W168823	98.55
	12"	Heavy Duty	6 LG Pad	W165356HD6	174.15	W168823	98.55
1750 Gas	13"	S/N 190958: ↓	Woven	W160974	125.55	W168011	139.19
	13"	S/N 191356 thru 19153	6 Pad	W164008	147.30	W168011	139.19
	13"	Optional w/Dynalife Disc	6 LG Pad	W164008HD6	160.81	W168011	139.19
	13"	Heavy Duty					
1750 Diesel	12"	EFF S/N 190958 ↓	4 Pad	W165356	112.05	W168823	98.55
	12"	Heavy Duty	4 LG Pad	W165356HD4	125.55	W168823	98.55
	12"	Heavy Duty	6 LG Pad	W165356HD6	174.15	W168823	98.55
1750 Diesel	13"	S/N 190958 ↓	Woven	W160974	125.55	W168011	139.19
	13"	Optional w/Dynalife Disc	6 Pad	W164008	147.30	W168011	139.19
	13"	Heavy Duty	6 LG Pad	W164008HD6	160.81	W168011	139.19
1755	12"		4 Pad	W165356	112.05	W168823	98.55
	12"		4 LG Pad	W165356HD4	125.55	W168823	98.55
	12"	Heavy Duty	6 LG Pad	W165356HD6	174.15	W168823	98.55
1800	12"	Tractors w/12" Clutch	Woven	W156217	112.05	W107175	96.95
1800	13"	Tractors w/13" Clutch	Woven	W160974	125.55	W168011	139.19
	13"		6 Pad	W164008	147.30	W168011	139.19
	13"	Heavy Duty	6 LG Pad	W164008HD6	160.81	W168011	139.19
1850	13"	Gas S/N 198394 ↓ & Diesel S/N 194008 ↓	Woven	W160974	125.55	W168011	139.19
	13"	All S/N	6 Pad	W164008	131.23	W168011	139.19
	13"	All S/N Heavy Duty	6 LG Pad	W164008HD6	160.81	W168011	139.19
1855	13"		6 Pad	W164008	147.30	W168011	139.19
	13"	Heavy Duty	6 LG Pad	W164008HD6	160.81	W168011	139.19
1900	14"		Woven	W105635	163.35	W873573	186.30
1950	14"		Woven	W105635	163.35	W168668	170.27
1950T, 1955	13"		6 Pad	W3295842	160.65	W168011	139.19
	13"	Heavy Duty	6 LG Pad	W3295842HD6	160.81	W168011	139.19

**Your model not listed? Give us a call and we will see if we can locate parts for you.
If you are looking for bearings, clutch disc, and Pressure Plate Assembly; check
out our Clutch Kits page. Just another way T.H.E. Company saves you money.**

HYDRAULIC/4
DRIVETRAIN 4

We make
ordering easy
1-800-634-4885

NEW/REMAN CLUTCH KITS

T.H.E. Company
offers five easy ways to pay



*LISTED PRICES ON REMAN ARE EXCHANGE - CORE CHARGES APPLY

*KITS CONTAIN CLUTCH DISK, PPA, AND BEARINGS UNLESS OTHERWISE NOTED

INTERNATIONAL HARVESTER

ORDER #	APPLICATION	WT	PRICE
375493KIT	A,B,C, SUPER A & C 100 130 140 200 230 240 404	C/T	191.89
52900KIT	H & HV	C/T	203.85
52840KIT	11" WOVEN REMAN - M,MD,W6 (SER. # FBK501-FBK294707)	C/T	174.15
357299KIT	12" WOVEN REMAN - M,MD,MV, SUPER M (FBK294708 up)	C/T	209.25
357299OILKIT	M,MD,SUPER M, SUPER MD - USE ONLY IF YOUR TRACTOR IS EQUIPPED W/ BELLY PUMP	C/T	217.35
360746KIT	300 350 460 606 544	C/T	215.95
359121KIT	SUPER MTA, 400 450 460	C/T	236.49
405299KIT	12" SIX PAD REMAN - 706 756 766	C/T	275.49
405300KIT	12" SIX PAD REMAN HD PPA - 706 806 756 826 856 766 966 786 886 986 3088 3288	C/T	275.68
390254KIT	14" SIX PAD REMAN - 1206 1256 1456 1066 1466 4166 1086 4186	C/T	345.95
67597KIT	HEAVY DUTY 14" SIX PAD REMAN - 1206 1256 1456 1066 1466 4166 1086 1486 4186	C/T	352.70
67735KIT	14" 6 PAD REMAN - 1566 1568 1586	C/T	352.70

FORD

F8N63SKIT	REMAN CLUTCH KIT - 2N,9N,8N,NAA,JUBILEE, 600 700 800 & 900 SERIES	C/T	170.27
F8N63SNKIT	NEW CLUTCH KIT - 2N,9N,8N,NAA JUBILEE, 600 700 800 & 900 SERIES	25	197.30

JOHN DEERE

R31310RU1	REMAN WOVEN CLUTCH - 3010 & 3020 SYNCO-MESH - NO BEARINGS	C/T	598.65
R31310RU2	REMAN SIX PAD CLUTCH - 3010 & 3020 - NO BEARINGS	C/T	622.40
R31310NU1	NEW WOVEN CLUTCH UNIT - 3010 & 3020 SYNCHRO-MESH - NO BEARINGS	75	660.81
R31310NU2	NEW SIX PAD CLUTCH UNIT - 3010 & 3020 SYNCRO-MESH - NO BEARINGS	75	699.30
R41410RU1	REMAN WOVEN CLUTCH UNIT - 4010 4020 BEL SN 145659 SYNCRO-MESH BEARINGS ARE NOT INCLUDED	C/T	630.45
R41410RU2	REMAN SIX PAD CLUTCH UNIT SYNCRO-MESH 4010 4020 BEL SN 145659 - BEARINGS ARE NOT INCLUDED	C/T	670.27
R41410NU1	NEW WOVEN CLUTCH UNIT - 4010 4000 4020 ALL SYNCRO-MESH - NO BEARINGS	80	648.00
R41410NU2	NEW SIX PAD CLUTCH UNIT - 4010 4000 4020 ALL SYCRO-MESH - NO BEARINGS	80	685.14

MASSEY FERGUSON

M526664N	NEW 11" HEAVY SPRING WOVEN CLUTCH DISC KIT - 65 165 175 180	35	390.15
M526665NKIT	NEW 11" MEDIUM DUTY WOVEN CLUTCH DISC KIT - 65 165 175 180	35	390.15
M526666NKIT	NEW 11" LIGHT DUTY WOVEN CLUTCH DISC KIT - TO35 35 50 150 135	35	390.15
M8338761	DIAPHRAM & CLUTCH DISC UNIT - BEARINGS ARE NOT INCLUDED 3050 3060 3070 3065 3075 3095 3090 - ALL TO ENGINE SERIAL # C340006	C/T	540.01
M3713903	NEW DIAPHRAM PPA & CLUTCH DISC UNIT - BEARINGS NOT INCLUDED 3050 3060 3065 3070 3075 3090 3095 - ALL MODELS AFTER ENG SER # C340006	C/T	540.01

HYDRAULIC/
DRIVETRAIN

We make
ordering easy
1-800-634-4885
www.the-co.com

DRIVETRAIN

T.H.E. Company
offers five easy ways to pay

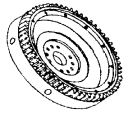

NEW FLYWHEELS WITH RING GEARS MADE IN USA!

ORDER #	APPLICATION	CASE	OUR PRICE
A153946H	2470 and 2670 with PTO 2090, 2290, 2390, 2590, 4490, 4690, 2094, 2294, 2394, 2594, 3294, 3394, 3594, 4494, 4694		\$595.36

Wt. 106 lbs.

INTERNATIONAL			
3136044RH	584, 684, H84, 784, 574, 674, 585, 595	48 lbs.	471.25
388302RH	656 Diesel Gear	70 lbs.	543.75
341603RH	856, 1026	85 lbs.	576.81
672215CH	1066, 1086, 1466, 1486, 1566, 1586	96 lbs.	523.74
142022CH	3388, 3588, 3788, 6388, 6588, 6788	82 lbs.	500.25

JOHN DEERE			
HCAR40565H	3010, 3020, 4000, 4010, 4020 Syncro Range	175.0 lbs.	439.19
AR48294H	400, 500 Series engines w/R46045 Casting #	78.5 lbs.	574.35

OLIVER			
168805ASH	1650 (SN 187586 and up) 1655	Avg. Wt. 73 lbs.	500.25
101765AH	1550, 1555, 1600, 1650, 1655 and 2-70		121.01



STARTER RING GEARS MADE IN USA!

70209292H	AC	B & C	1.6 lbs.	34.22
70226830H	AC	D-17, 170, 175 GAS 139 TEETH		39.75
9N6384H	Ford	8N 134 Teeth	3.2 lbs.	30.00
70208132		WC, WF, WD, WD45		39.31
E2NN6384AA	Ford	Most 3, 4, 6 cyc Diesels	5.5 lbs.	35.95
A27920H	Case	30 series, 1470, 2470, 2670, 2090 thru 4690 and 94 series	7.6 lbs.	56.55
A58778H	Case	70 series except 1470, 1175 and 1090	9.5 lbs.	90.00
A27920H	CASE	All others		56.55
R28811H	JD	Most DIESEL Applications		
		129 teeth 16.353OD, 15.171ID, .562 Width	4.0 lbs.	66.95
R26054H	JD	MOST GAS APPLICATIONS 165 TEETH		71.60
R114282H	JD	Most utility tractors 2355-2955, 2840, 2940		
		142 teeth, 14.325OD, 13.370 ID, .406 Width	3.5 lbs.	31.30

INTERNATIONAL			
55755DBH	A, B, C, Super A, 100, 140, 200, 230, 240	2.0 lbs.	20.18
45638DBH	H, Super H, 300, 330, 340, 350	3.5 lbs.	31.00
46142DBH	M, MD, Super M, Super MD, 400, 450 gas & diesel	6.5 lbs.	70.99
60883CH	544, 574, 584, 684, 784	4.0 lbs.	64.89
367042RH	460, 504, 544, 656, 666, 686	3.0 lbs.	52.35
341604RH	706, 756, 856, 1026, 826, 786, 886, 3088, 3288, 966, 986, Hydro 86, Hydro 100, Hydro 186, 766, 886, 3488, 3688	4.5 lbs.	51.45
326759RH	1256, 1456, 4156, 1066, 1466, 1566, 1086, 1486, 1586, 4166, 4186, 3588, 3788	6.0 lbs.	83.17

JOHN DEERE 2 CYL. BELT CLUTCH

	Order #	Application	Description	Our Price
Wt. 1 lb.	C614RH	A, 60, 70, 620, 630, 720, 730	Pulley clutch facing	\$10.50
	C614RH	B158RH	B, (early), BR, BO	Floating disc 12.37
		B2354RH	B, (late), 50, 520, 530	Floating disc 12.66
	AA6129H	AA6129H	A, 60, 70, 620, 630, 720, 730	Pulley clutch disc w/facing 41.53
	AA6129H	F821H	H, 60, 70, 620, 630, 720, 730	Clutch cover 26.25
		B3764RH	B Ser #201,000 up, 50, 520	Clutch cover 26.05
	A4355RH	A4355RH	A, 60, 70, 620, 630, 720, 730	Splined clutch plate 65.35
	A4355RH	F1228RH	70, 720, 730	Clutch drive disc 122.74
		A4391RH	60	Clutch drive disc 148.91
	A4028RH	A5642RH	620, 630	Clutch drive disc 216.96
	A4028RH	A4028RH	A	Clutch drive disc 138.82

Quick Attachable Pulley Brake Lining

Wt. 1 lb.

New Lower Price



- Fits A, B, G, 50, 60, 70, 520, 530, 630, 720, 730
- Woven lining with countersunk brass rivets.

Order #AB4748RH

\$7.85

JD 4010/4020 Clutch Components

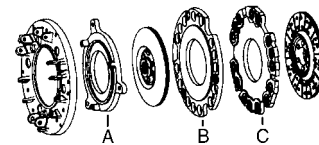

Ref.	Order #	Description	Our Price
A	R44831H	Rear PTO Plate All 4010, 4020	\$ 52.81
B	R26799H	Front PTO Plate All 4010, 4020, 145659 ↓	65.25
C	R33552H	Clutch Plate All 4010, 4020, Ser #145659 ↓	90.54

Wt. 1 lb.

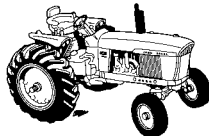

Clutch Pilot Bearings & Throw Out Bearings



Release	Bearing	Pilot Price	Bearing	Price	Release	Bearing	Pilot Price	Bearing	Price
	AC					JD			
B, D10, D12, WC, WF, WD, WD45	832063	\$31.08	836205	\$12.16	1010, 1020, 1520, 2010-2030, 2150, 2155,	8225518	\$22.97	JD9449	\$4.99
C, CA, D10-D19, ED40, 180, 185, 190, 190XT, 200	832065	20.95	836205	12.16	2240, 2255, 2355, 2440, 2630, 2640, 4520,				
D17, D21, 170, 175, 210, 220, 7000	832505	25.68	836205	12.16	4620, 7020				
5040, 5050, 6060, 6070, 6080	8512202	78.38	836304	12.84	2510	830166	41.89	JD9449	4.99
	IH				2510, 3020, 4000, 4010, 4020, 4320	832065	20.95	JD9449	4.99
A, B, C, Super C, H, HV, Super H, 100, 130,	832063	31.08	836205	12.16	3010, 3020	833535	25.68	JD9449	4.99
140, 200-240, 404 200-240, 404						Case			
M, MD, Super M, Super MD	8225518	22.97	836205	12.16	400, 700, 730, 770, 830, 870	832255	25.00	836007	18.92
Super MTA, 400, 450, 560, 660, 706-786, 806,	832505	25.68	836304	12.84	930, 970, 1030, 1070, 1090, 1170, 1175, 1470	832505	25.68	836007	18.92
886, 966, 986, 1066-1086, 1206-1256, 1456,			836205	12.16	385-985	832375	25.68	836204	11.21
1486, 1566-1586, 2706, 2756, 2806-2856, 3088,			836304	12.84		Massey Ferguson			
3288, 3388, 3588, 3688, 3788, 4100,-4186,					TE20, TO20	832065	20.95	836203	12.15
6388, 6588, 6788, 2106-21456					TO35, TO40, 203, MH50, 35, 55	832505	25.68	836203	12.15
300-350, 424-484, 504, 544, 574, 584, 606, 656,	832375	25.68	836204	11.21		Oliver			
664, 674, 684, 686, 784, 884, 2400A, 2400B,					1650, 1655	832065	20.95	836007	18.92
2444, 2500A, 2500B, 2504, 2544, 2606, 2656, 3500A					1750, 1850, 1855	8225518	22.97	836008	24.32

HYDRAULIC/4
DRIVETRAIN 6

IH TORQUE AMPLIFIER KITS

T.H.E. Company
offers five easy ways to pay



PRICES LISTED ARE EXCHANGE, CORE CHARGES APPLY

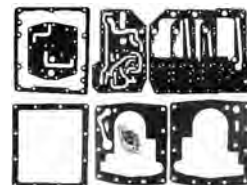

HYDRAULIC TORQUE-AMPLIFIERS & TA ELIMINATION ASSEMBLIES FOR

706 806 1206 756 856 1256 1456 766 966 1066 1466 1468 786 886 986 1086 1486

		PRICE	WT
74493	STANDARD DUTY TA	674.32	80
529091HD	HEAVY DUTY TA	755.41	80
392292	SUPER DUTY TA	945.15	85
830431	TA ELIMINATION KIT	487.84	65
79020	TA AND TA ELIMINATION GASKET KIT	72.97	4



HYDRAULIC TORQUE AMPLIFIERS & TA ELIMINATION ASSEMBLIES FOR 1566 1568 1568 1586

74494	STANDARD DUTY TA	673.65	80
68135HD	HEAVY DUTY TA	755.41	80
68135HDS	SUPER DUTY TA	955.55	85
830432	TA ELIMINATION KIT	556.76	65
79018	TA AND TA ELIMINATION GASKET KIT	72.97	4



MECHANICAL TORQUE AMPLIFIERS & ELIMINATION KITS

SMTA, 400, 450, 560, 660

363499	STANDARD DUTY TA	539.19	50
363499HD	HEAVY DUTY TA	836.49	50
363499E	MECHANICAL TA ELIMINATION ASSEMBLY	496.80	35
830450	MECHANICAL TA ELIMINATION KIT	359.46	30



300, 350 460 - ALL FARMALL ROW CROP MODELS

363854STD	STANDARD DUTY TA	539.19	60
363854HD	HEAVY DUTY TA W/ HEAVY DUTY SPRAG	835.65	60
836854E	MECHANICAL TA ELIMINATION ASSEMBLY	496.80	60
830450	MECHANICAL TA ELIMINATION KIT	359.46	60



300, 350, 330,340,504,544 - ALL INTERNATIONAL UTILITY MODELS

*402778STD	STANDARD DUTY TA	539.19	60
*402778HD	HEAVY DUTY TA	836.49	60
*8402778E	TA ELIMINATION ASSEMBLY	496.80	60
*830450	TA ELIMINATION KIT	359.46	60



*PRIOR TO ORDERING FOR ABOVE MODELS - BACK GEAR ON TA MUST BE IDENTIFIED BY THE FOLLOWING MEASUREMENTS: BEARING BORE 2.130" TEETH LENGTH 1.050"

656, 666, 686

394814STD	STANDARD DUTY TA	538.65	60
394814HD	HEAVY DUTY TA	835.60	60
839814E	MECHANICAL TA ELIMINATION - INCLUDES GASKET KIT	496.80	60
830450	TA ELIMINATION KIT	359.46	60



4-7
HYDRAULIC/
DRIVETRAIN

We make
ordering easy
1-800-634-4885

HYDRAULIC PUMPS

T.H.E. Company
offers five easy ways to pay



Avg. Wt. 7 lbs.

New International Harvester Multiple Control Valve Hydraulic Pump

Order #	Application	Capacity— G.P.M.	Our Price
527397	706-756 766-806-826-856 966-1026	9	\$274.95
120114	786-886 986-1086 1486-1586 3088 3288 3688	12	284.95
527397RH	706, 756, 766, 806, 856, 826, 966, 1026 Remanufactured	9	\$295.95
120114CH	786, 886, 986, 1086, 1486, 1586, 3088, 3288, 3688 Remanufactured	12	295.95



Wt. 10 lbs.

IH Hydraulic Pump

Order #128190CH Gas models 400, 450 Super M
Super MTA, Super W6, Super W9, 12 6 GPM cap
@1450 RPM 1200 PSI.

our price only \$685.00

Order #128191CH Gas 300, 350 Super H, 10 GPM
at 1600 RPM, 1200 psi. Avg. Wt. 15

our price only \$685.00

Order #384506N IH Super C

our price only \$404.05



Wt. 6

International Harvester New Main Hitch Hydraulic Pump

Order #	G.P.M.	Application	Our Price
70933	12 open	330-340 460 504 544 560 806 656 660 706 756 766 1066 1256 1466 100 Hydro	\$349.95
70935	17 open	806 856 1026 1206 1456D 664 666 686 1456 3488 3498 Hydro 70-86	
70931	12 closed	786 886 1086 1486 1586	379.95
70932	15 closed	786 886 1086 1486 1586 3088 3281 3688	339.95
70933	12 open	1566-1568	289.95
1263450CH	17 closed	All 2+2s 1980 and 86 series	349.95
371135	Power Steering Pump	330, 340, 460, 560, 660	1,336.49 \$403.65



Power Steering Units

Order #	Description	Price
2171015	S101-F Power Steering Unit	\$517.79
2171020	S102-F Power Steering Unit	538.72
Order #	Seal Kit For:	Price
21122	S101-F & S102-F	\$35.53
581H	S101-E & S102-E	32.95
581H	S101 & S102 A thru D	32.95

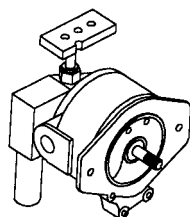

Avg. Wt. 11.5 lbs.

Oliver Pump

303062449H	Oliver Pump Open Center Tractors w/internal Hydraulics	1600, 1650, 1655, 1700, 1800, 1850, 1950, 2-70	\$538.04
W30624491H	Oliver Pump Conversion Kit Tractors w/external Hydraulics	1600, 1650, 1750, 1800, 1850, 1950, White 2-70	\$562.16



IH Conversion Kits

Converts the expensive hi-maintenance
Axial Pump to a more reliable Gear Pump

830457 ↓ 3388, 3488, 3588, 3688, 3788,
6388, 6588, 6788 32 lbs. **\$1128.38**
Also need to order 70933 or 70932 Gear Pump

830446 Converts 2 + 2 steering Conversion Kit
converts from the expensive
Hi-maintenance Axial Pump to a
more reliable Gear Pump 25 lbs. **906.76**
*Includes New Gear Pump

We make
ordering easy
1-800-634-4885

HYDRAULIC PUMPS

T.H.E. Company
offers five easy ways to pay

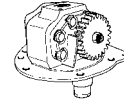
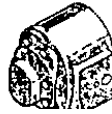

Deutz 1176000 Ford

New Steering and Hydraulic Pumps Oliver, White, Deutz, Ford, Massey

Avg. Wt. 15 lbs

Make	Order #	Description	Application	Our Price
Ford	DONN600FH	Hydraulic Pump Trans. Mounted	3550, 4400 (65 and up)	\$698.04
Ford	DONN600GH	Hydraulic Pump Trans. Mounted	5100, 5200, 7000, 7100, 7200 (65-75)	471.15
Ford	D5NN600CH	Hydraulic Pump Trans. Mounted	8000, 8600, 8700, 9000, 9600, 9700 (68-78)	539.19
Ford	D8NN600FAH	Hydraulic Pump 16 gpm Trans. Mounted	TW10, TW20, (79-82) TW5, TW15, & TW25	427.03
Ford	D8NN600KB	Hydraulic Pump Trans Mounted	5600, 5700, 6600, 6700, 7600, 7700	465.72
Ford	E2NN600BAH	Hydraulic Pump Trans. Mounted	TW30 & TW35	604.02
Ford	E1NN600AH	Hydraulic Pump Engine Mounted w/spin on filter	2600, 3600, 2310, 2610, 3610, 5610, 6610, 6710, 7610, 7710, 7910, 8210, TW5 & TW35	453.78
Ford	C7NN3A674BH	Steering Pump 4.2 GPM, 1500 psi	8000, 8600, 8700, 9000, 9600, & 9700 (68-73)	622.75
Ford	C7NN3A674GH	Steering Pump 3.5 GPM, 1100 psi	4200, 5200, 7200	685.68
Ford	D6NN3K514BH	Steering Pump w/reservoir	8000, 8600, 8700, 9000, 9600, 9700 (3/73 & 7/76)	758.71
Ford	D8NN3K514JCH	Steering Pump w/reservoir	TW30 & TW35	673.65
Ford	E6NN3K514EAH	Steering Pump 2.74 gpm, 1100 psi	2600, 3600, 4100, 4600 su 3500, 3550, 5100-7100	
Ford	C3NN3A691BH	Steering Pump	4100 (4170 & up) 4600, 5600, 6600, 7600, 231, 233, 531, 532, 333, 335 Ind. Old Style 600-900, 601-901, 2000-4000 to 1965 gas only	268.65 575.00
Deutz	D1176452H	Hydraulic Pump	4506-100-06, DX160	295.95
Deutz	D1176000H	Double Hydraulic Pump 16cc & 12cc w/tapered shaft	D8006, 100-06, 130-06, 6807, 7207, 7807	639.00
Deutz	D1174406H	Single Pump Splined	DX160, 140, 710	299.00
Deutz	D1176451H	Double Pump 22.5cc and 14cc	DX85, 90, 110, 120, 130	651.05

Ford Power Steering Cylinders and Kits

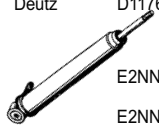

E2NN3A540BH	Single Cylinder with 1/20 Rod w/7/160 Thread, can be used on either Right or Left side by turning rod end. Fits: 601, 801, 2000, 2600, 2610, 3000, 3600, 3910, 4600SU, 4610SU, 230A, 530A, 234, 334, 335, 531.	232.00
E2NN3D547AAH	Same as above w/5/8 Rod 7/16 Thread	240.43
C5NN3A302BH	Tie Rod for either Cylinder above 7/160	22.98
60666	Seal Kit for 1/2 Rod cylinder above	44.75
60668	Seal Kit for 5/8 Rod cylinder above	34.29

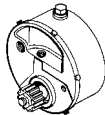

773126MH

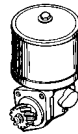

544443MH

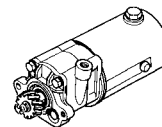

MF 1686

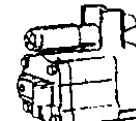

766M91

Massey	544443MH	Steering Pump Assembly with reservoir	T035, MF35, MF40, MF50, MH50, MF135, MF150	565.65
Massey	773126MH	Steering Pump Assembly w/reservoir	MF35, 50, 35, 230, 245, 250, MOST MF Forklifts	282.15
Massey	523089MH	Steering Pump Assembly w/reservoir & drive gear	MF285, 1080, 1085	330.75
Massey	523090MH	Steering Pump Assembly w/reservoir & drive gear	MF 65, 165D, 2556, 30, 40, 50, 203, 204, 256, 3165 DSLs	330.75
Massey	523092MH	Steering Pump Assembly w/reservoir & drive gear	MF165G, 175, 255, 265, 275	330.75
Massey	886821MH	Auxiliary Hydraulic Pump (Single)	MF135, 150, 165, 175, 235, 245, 255, 265, 275, Most MF Backhoes	317.12
Massey	1686765MH	Auxiliary Hydraulic Pump (Double)	MF240, 250, 270, 298, 670, 690, 698, MF4840	595.00
Oliver/White	W3141764H	Hydraulic Pump Closed Center	1755, 1855, 1955, 2255, 2-85, 2-105, 2-135, 2-155, 2-180, 4-150, 4-180	714.00
Oliver/White	303062449H	Hydraulic Pump Open Center Gear Pump	1600, 1650, 1750, 1800, 1850, 1950, 2-70	538.04

Ford 9N, 2N & 8N, MF TO20, Hydraulic Pump Parts

Complete Rebuild Kits

Kit contains reference A thru J

Qt.	Reference #
1	A
2	B
2	C
2	D
1	E
1	F
1	G
2	H
1	I
2	J

only \$189.95

Order #8NOH

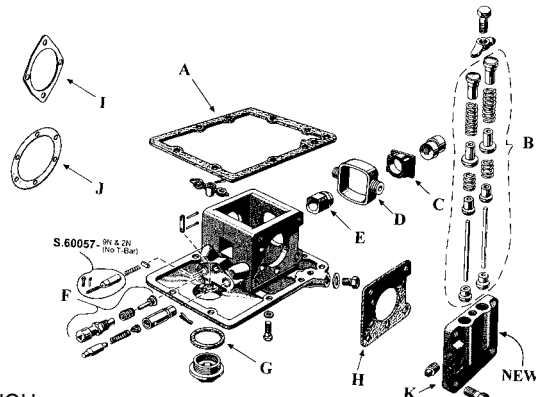

Kit with New Valve Chamber

Kit contains reference A thru K

Qt.	Reference #
1	A
2	B
2	C
2	D
1	E
1	F
1	G
2	H
1	I
2	J
2	K

Order #8NOHC

only \$433.55

HYDRAULIC/
DRIVETRAIN

We make
ordering easy
1-800-634-4885

HYDRAULIC/PUMPS

T.H.E. Company
offers five easy ways to pay



JD Drive Couplings

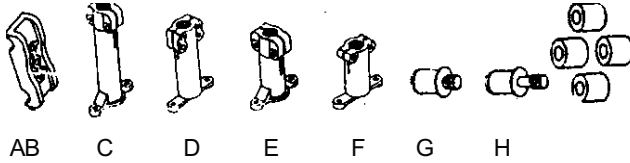

Ref	Order #	Application	Wt.	Price
A	R34362H	Coupler half 20, 30 40 Series	3 lb.	\$19.28
B	R50215H	Coupler shaft 4430 4630, 4240, 4440	3 lb.	105.90
C	T31093H	Coupler shaft 4230, 2840	3 lb.	76.49
D	R43075H	Coupler shaft 4320, 4520, 4620, 7020, 4230, 440	3 lb.	104.11
E	R34359H	Coupler shaft 3020, 4000, 4020, 5010, 5020	3 lb.	52.35
F	R34360H	Drive Pin Coupler End 3020 thru 7020 4230 thru 4630 4040 thru 4440 2840	.5 lb.	3.41
G	R46345H	Drive pin engine end same as above	.5 lb.	3.77
H	R45822H	Drive bushings all JD 10 thru 55 Series	.5 lb.	1.87

Drive Couplings

New & Reman Piston Pumps



*Core Charges apply on New and Reman units

Order #	Application	Exchange Price
R103033N	8 piston, keyed shaft, 1020, 2030, 2630, 2040, 2240, 2640, 2020, 2640, 2020,	1213.65
R103033R	2250,2450,2650, 1520, 2630, 2440	1097.55
R94657NH	Eight piston, Replaces OEM # AR97872 2030 2630 2040 2240 2640 2840 2350	1120.27
R94657R	2550 2750 2950 3150 2155 2355 2555 2855 2955 3155	1028.20
R94658NH	Eight piston, w/o mechanical front axle 3010 4010 4000 4020 4320 4520 4620 5010 5020 4030 4230 4430 4630 8430	1120.27
R94658R	8630 4040 4240 4440 4640 4840 4050 4250 4650 4255 4455 w/o serial plate	1028.20
R94659NH	Eight piston, Replaces OEM # AR97872 2030 2630 2040 2240 2640 2840 2350	1119.15
R94659R	2550 2750 2950 3150 2155 2355 2555 2855 2955 3155 with serial plate	1028.71
R94661NH	Eight piston, mechanical front axle 4440 4640 4840 4250 4450 4650 4850	1414.80
R94661R	4555 4755 4955 4560 4760 4960	1281.15
R94660NH	Eight piston, With Serial Plate 2 Ports 7/8" pressure and suction	1119.15
R94660R	3020 4000 4020 w/o mech. front axle	1028.70

Hydraulic Conversion Kits

Change your old lever style female body over to the ISO tip used by every manufacturer

Wt. 4 lbs.



Order #	Our Price
IH8700	only \$152.95
JD8800	only \$117.11
Ford8900	only \$129.95

Cross Hydraulic Valves

- Valve comes with 2 handles and linkage
- 3/4 NPT in and out ports (1/2 NPT cylinder ports)
- 2500 PSI working pressure
- 30 GPM flow rate
- Adjustable relief valve preset @ 2000 PSI



Description	Order #	Price
Open Center System	SBAF2	\$312.95
Closed Center System	SBAF2JD	\$312.95
Optional Mounted Joystick	V1451	\$71.55

Pioneer Replacement Hydraulic Tips and Adapters



Order #	Description	Male Tips Thread Size	Only
80104	ISO	1/2" Pipe	5.95 ea.
801015	ISO	3/4"-16 O-Ring	7.75 ea.
801016	ISO	7/8"-14 O-Ring	9.55 ea.
50604	JD Old Style	1/2" Pipe	7.95 ea.
506015	JD Old Style	3/4"-16 O-Ring	7.95 ea.
50704	IH Old Style	1/2" Pipe	11.99 ea.
507016	IH Old Style	7/8"-14 O-Ring	12.83 ea.
		42504	
		40564	
		405615	
		40574	
Female		Couplers	
42504	ISO	1/2" Pipe	15.25 ea.
40564	JD Old Style	1/2" Pipe	21.34 ea.
405615	JD Old Style	3/4"-16 O-Ring	19.70 ea.
40574	IH Old Style	1/2" Pipe	24.99 ea.

We make
ordering easy
1-800-634-4885

HYDRAULIC CYLINDERS

T.H.E. Company
offers five easy ways to pay



Quality and Price, That's What You Get With . . .

LION HYDRAULICS CYLINDERS



Hydraulic Cylinders

- 2 year warranty
- 2500 continuous working pressure
- Double acting convertible to single
- Double ported
- All cylinders manufactured to S.A.E. standards
- Sizes from 2 x 8 to 5 x 24

Model #	Wt.	Diameter Stroke	Rod Diameter	Our Price
20TL08	18	2 x 8	1 1/8	\$ 92.86
25TL08	21	2 1/2 x 8	1 1/8	86.59
30TL08	26	3 x 8	1 1/4	95.77
35TL08	29	3 1/2 x 8	1 1/4	111.42
40TL08	35	4 x 8	1 1/4	128.95
50TL08	55	5 x 8	1 1/2	192.15
50TL10	65	5 x 10	1 1/2	242.39
30TL10	27	3 x 10	1 1/4	97.17
30TL12	29	3 x 12	1 1/4	105.39
30TL16	33	3 x 16	1 1/4	140.95
40TL16	50	4 x 16	1 1/4	187.45
40TL18	55	4 x 18	1 1/4	203.74
30TL24	41	3 x 24	1 1/2	144.49
40TL24	66	4 x 24	2	238.04
30TL36	62	3 x 36	1 1/2	214.15
40TL36	99	4 x 36	2	330.63

Electric Second Valve

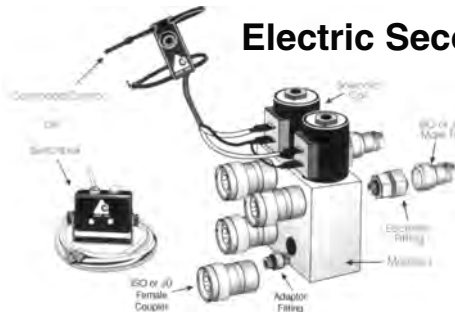

- An inexpensive way to add a second valve.
- Kit comes complete with all tips, couplers and wiring.
- Mounts directly into the tractors S.C.V. Couplings.

14789H	Two circuit with com. control/couplers	\$363.00
14790H	Two circuit with switchbox/couplers	377.00
14791H	Two circuit with switchbox/JD couplers	391.00
18549H	Two circuit with com. control/no couplers	327.00
18550H	Two circuit with switchbox/no couplers	334.00
12369H	Three circuit with com. control/couplers	471.25
12370H	Three circuit with switchbox/couplers	513.95
16929H	Three circuit with com. control/no couplers	435.55
16930H	Three circuit with switchbox/no couplers	442.35
653012H	Solenoid Coil-12V	44.50
673004H	Cartridge Valve	73.54
674001H	Seal Kit - Included with Cartridge	10.21
706249H	Pushbutton Switch - 2 Circuit	67.54
706250H	Switchbox Control - 2 Circuit	75.22
706295H	Switchbox Control - 3 Circuit	112.52

Cast Iron Cylinder Stops

Avg. Wt. 8 lbs.



Spacer kit consists of
5 pair of segments.

	Order #	Rod Dia.	Ship Wt. lbs	Our Price
2 pair - 1:"wide	639070	1 1/8"	4	\$18.95
1 pair - 1 1/4" wide	639120	1 1/4"	4	19.95
1 pair - 1 1/2" wide	639240	1 1/2"	4	20.95

Hydraulic Coupler Clamps



Desc.	Order #	Price
Single Coupler	50014	\$8.95
Dual Coupler	50064	\$14.49



HYDRAULIC/
DRIVETRAIN

We make
ordering easy
1-800-634-4885

BRAKES

T.H.E. Company
offers five easy ways to pay

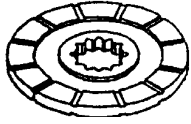

Bonded Brake Discs

Many more applications available—
just a simple call!

Order #	Application	Our Price
CASE Avg. Wt. 5 lbs.		
1975466CH 7"	730, 830, 930, 1030, Early 770, 870, 970 (Replaces A44712)	\$17.15
1975469CH 8"	Late 770, 870, 970 and 1070, 1175 (Replaces A65189)	\$20.50
FORD		
8N2200B	8N, NAA (Price per shoe)	\$12.60
NCA2218BH	600, 700, 800, 900, 601, 701, 801, 901, 2000-4000, 1955-64 (Price per shoe)	\$21.95
E1ADDN2284H	Fordson Super Major Brake kit 4 linings - 48 rivets	\$30.00
F2NN2218AAH	Fits 2000, 3000, 2600, 3600, 2610, 3610 (Price per shoe)	\$20.00
D9NN2218AAH	2 Shoes, 2000, 3000, 4110, 12/66†, 2600, 3600, 2610, 3610 (Price per shoe)	\$19.98
MASSEY FERGUSON		
830537MH	2 Shoes, TO20, TO30 (Price per shoe)	\$15.97
830480MH	2 Shoes, TO35, MH50, MF35, 135, 150, 230, 235, 245 (Price per shoe)	\$20.45
1021314MH	65, 85, 88, 90, 135, 165, 175, 180 (Replaces 1753117M91)	\$19.55
1044526MH 8 7/8"	Square axle 135, 165, 175, 180, 235, 255, 265, 275, 285 (Replaces 1805980MI)	\$26.01
1884029MH 7"	VI Keolar MF 65, 165, 175, Dry brakes	\$14.33
INTERNATIONAL		
1963810CH	M, Super M, W6, 400, 450 (Replaces 121961092 & 321162R91)	\$16.99
1975446CH	560, 660, Tractors and 403, 503, 915, 1460, 1480 Combines (Replaces 121963C91 & 369079R91)	\$19.28
1975456CH	Super C, 200, 230, 240, 330, 340, 404, 2404 (Replaces 368181R92)	\$13.60
1975457CH	Super H, 300, 350 (Replaces 368183R91)	\$13.75
1975460CH	340 D5L, 460, 504, 606, 2504, 2606 (Replaces 368292R92)	\$14.75
1975463CH	656, 666, 686, 2656, Hydro 70 and 86	\$17.63
1975464CH	354, 364, 384, 424, 444, 2300, 2424, 2444 (Replaces 395161R1)	\$16.81
1975468CH	706, 806, 756, 826, 856, 1026, 766, 966, 1066 (Replaces 384166R92)	\$26.04
1975472CH	1456, 1466, 1468 (Replaces 528702R2)	\$85.62
384368RH	Brake Piston for 706-1206, 756-1456, Hydro 100, 766-1466	\$90.84
International Brake Seal Kit		
DISC BRAKE SEAL KIT		
66487CH	706, 806, 756, 826, 856, 1026, 766, 966, 1066	\$14.18
Includes brake piston O-rings and brake pinion seal. Kit is complete for one side of tractor!		
OLIVER		
106724AH	1550, 1555, 1600, 1650 and MM 550 & 750	\$15.88
303135241H	1750, 1755, 1800, 1850, 1950, 1950T, 1955, 2050, 2255 and White 2-85, 2-88, 2-105, 2-110, 2-150, 4-175, 4-180	\$25.95

Brakes

Wt. 1 lb.

7/8 Ball

Brake actuator Ball fits Case, IH, JD, White

Order
17028RH

Only
1.53

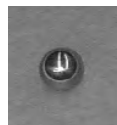

Wt. 1.5 lbs

Brake Bands and Linings



Order #	Model	AC	Type	Price
209864H	B, IB, C, CA		2 lining set	\$13.08
216775H	B & C lining and steel band			\$45.18
70230874H	D10, D12, D14, D15		2 lining set	\$19.63
231633H	WD, WD45, WD45D, D17, D17D Ser #42000		2 lining set	\$17.54
BLKAD17	D17, Ser #42000, D19, D21, 190, 180, 170		2 lining set	\$17.85
70235628H	D19, 190 Ser #21699, XT190 Ser #21699			\$33.29
70276914H	D17, Ser #, 170, 175, 180, 185			\$31.71
JD				
AA4253RH	A, G, 60, 70, 620, 630, 720, 720, 730, 730		Set of 4 w/rivets	\$19.95
AB3849RH	B (Ser #2010000), 50 Series		Set of 4 w/rivets	\$28.42
AF2866H	720, 730, 730D, 820, 830		Set of 4 w/rivets	\$36.83
MF				
830537MH	TO20, TO30		Priced per shoe	\$15.97
830480MH	TO35, MF35, F40, MF50, MF135, MF150		Priced per shoe	\$20.45
IHC				
51582DDXH	A, B, Super A Ser #339641 Band			\$36.39
358660RH	Super A 339642, 100, 130, 140 Band			\$32.66
358753RH	CUB Ser #173600 Band			\$30.65
58344DH	H Band			\$52.45
58345DH	M, Super M Band			\$59.08

WET BRAKE COMPONENTS

Wt. 17 lbs.

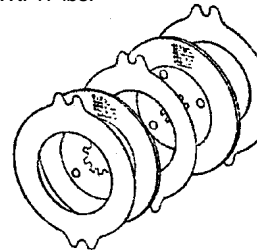

INTERNATIONAL Wet Disc Brake Overhaul Kit for All 86 and 88 Series.

- Kit Includes
- (6) 104712CH Fiber Discs
 - (7) 104713CH Steel Plates
 - (1) O Ring-seal kit

All parts available separately - (2) kits
required to complete one tractor

Order #120235CH

now only
\$179.83

JOHN DEERE

Wt. 11 lbs

Center Disc Plate for all wet brake tractors 3010-8650

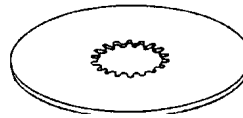

Part #	Description	Teeth	Diameter	Our Price
R26971H	3010	18	13.25	\$78.26
R33816H	3020, 4030	16	13.25	\$77.03
R58758H	4040, 4240, 4140	14	15	\$70.98
R62686H	4000, 4020, 4320, 4230, 4430, 4040, 4240, 4050, 4250 (use w/shaft R59928, R67198, R56731 or R62685)	15	15	\$61.63
R26767H	4010	18	15	\$78.33
R78430H	4000, 4020, 4320, 4230, 4430	15	15	\$111.05
R48864H	4520, 4620, 4630, 7020, 7520 (use w/shaft R43016)	13	17	\$86.49
R61140H	4840, 4850 (use w/shaft R61421)	14	17	\$86.49
R61712H	4520, 4620, 4630, 4640, 4650, 4840, 4850, 7020, 7520, 8630, 8440, 8640, 8450, 8650 (use w/shaft R63911 or R57614)	14	17	\$85.14

Replacement John Deere Brake Pads

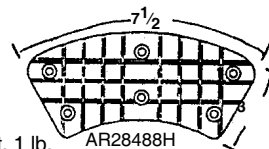

Wt. 1 lb.

AR28488H

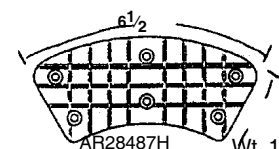

Wt. 1 lb.

Order #	Dimensions	Our Price
AR28487H	6 1/2" x 2 7/16"	\$12.54 per pad
AR28288H	7 1/2" x 3"	\$13.65 per pad

We make
ordering easy
1-800-634-4885

CONTROLS

T.H.E. Company
offers five easy ways to pay



Save Big \$\$\$ on IH Hi-Low Transmission Shift Kits!

• Fits all 56 and early 66 series tractors! 1971-74

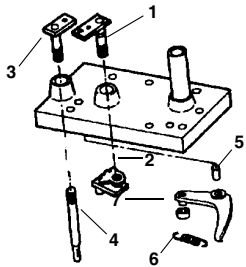

Ref.	Each Kit Contains:	Qt.
1	398281RH Splined Shift Kit	(1)
2	398285RH Splined Shift Arm	(1)
5	398300RH Control Arms	(2)
7	380115RH Detent Rollers	(2)
6	398304RH Tension Spring	(1)

Order #398281KIT
IH List \$259.74

our price only **\$140.65**

Hi-Lo Range Transmission Repair Kit 706, 806, 1206 Series IH Tractors

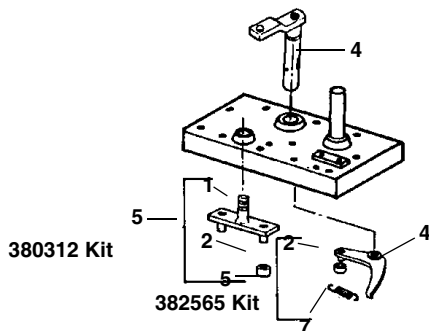

Order #	Our Price	Description	Ref.	Application
380312KIT	\$34.08	Pivot arm Kit - contains: (1) - 380312 R12 - Pivot arm (1) - 380115 R2 - Detent roller	1 2	706, 806, 1206 (1963-1967)
382565KIT	24.29	Control arm Kit - contains: (1) 382565 R21 - Control arm (1) 380115 R2 - Detent roller (1) 383997 R1 - Tension spring	3 2 7	Same as above
391018RH	35.82	Cam Pivot Shaft	4	Same as above

The **New 71526KT** Hi-Lo shifter kit eliminates the weak points. Highest quality materials and improved design assure correct fit, excellent performance and extra long life!

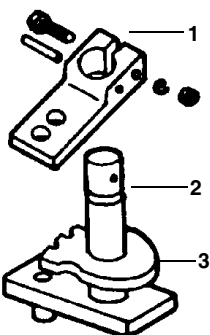

1. Thicker material in the lever insures tight fit. Lever is clamped and pinned.
 2. Shaft is 1/4 longer for better grip.
 3. Detent plate is temperature hardened for long life.
- Fits: Late 66 Series All 86, 88

Improve the performance and eliminate linkage wear.

Order #71526KIT

our price **\$90.00**

Avg. Wt. 1 lb.

Shift Knob/Boot

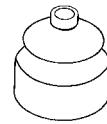

Deep Boot

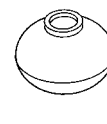

Shallow Boot



Shift	Knobs	
C5NN7213AH	Ford Shift Knob Speed 2000, 3000, 4000 w/8 Speed 65 to 75	\$3.25
E440GB9	Ford Shift Knob Range 2000, 3000, 4000, w/8 Speed 65 to 75	3.00
53717DAH	IH Knob Fits all IH round stock gear shifts	4.50
641H	John Deere shift knob black 820, 830, 840, 1020, 1030, 1040, 1520, 1530, 2020, 2030, 2150, 2240, 2350, 2440, 2510, 2520, 2550, 2630, 2640, 2750	3.09
72358H	John Deere Shift Red. Fits same as above	3.95
Shift Boots		
C5NN7277CH	3&4 Speed 2N, 8N, 9NNA, Jubilee, 600, 800, 900, 2000, 4000 (39-64)	3.95
C5NN275394H	Ford Shift Boot 2000, 3000, 4000 w/8 Speed trans. 65 to 75	2.50
M5491	Boot, Universal gear shift stretches to fit 1 1/2 and larger base, 1/2 and larger Shifter Shaft	1.99
L31055H	JD Shift Boot replaces all JD utility boots	2.95
180579MH	MF Shallow boot 35, 50, 65, 135, 150, 165, 175, 240, 265, 275	1.99
1678565MH	MF Deep boot same as above	1.99
L31055H	AC WC, WD, WD45	2.95
L31055H	All Olivers	2.95

IH no longer supplies these components!

IH Spring Loaded Park Lock Linkage

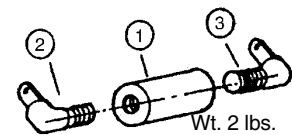

Wt. 2 lbs.

For tractors: 706, 756, 766, 806, 826, 856, 966, 1026, 1066, 1256, 1456, 1466, 1566, 1568. Also industrial versions of above.

(1) 390856RH	Turnbuckle	\$ 7.69
(1) 830244	Spring Loaded Turn Buckle	32.43
(2) 390857RH	Left Hand Park Lock Operating Rod	6.28
(3) 390858RH	Right Hand Park Lock Operating Rod	6.28

Transmission Brake IH Tractors — Helps stop gear grinding

Spring Loaded with Pad & Screw Application: All Tractors in the following series equipped with a mechanical Transmission Brake; 706 thru 1586, 3388, 3588, 3788, 4100, 4156, 4166 and 4168.

Helps stop excess gear grind.

Order #830299

our price only **\$90.54**

HYDRAULIC/
DRIVETRAIN

We make ordering easy
1-800-634-4885

PTO

T.H.E. Company offers five easy ways to pay



Avg. Wt. 5.5 lbs.

HUB CITY PTO INCREASERS, REDUCERS, AND ADAPTORS

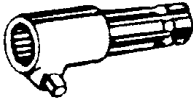

PART #033201375 (3030)
Quick Release PTO Adaptorour price **\$49.95** each
1-3/8-21 Spline Female x 1-3/8-6 Spline Male
Overall Length—7 5/8" Extends PTO—5 1/8"
Replacement Pin Kit 13006138our price **\$49.95** each

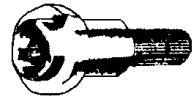

PART #033200013
KWIK-D-TACH PTO Adaptor with Patented Quick Release Devise.....our price **\$91.07** each
1-3/8-6 Spline Female x 1-3/8-21 Spline Male
Overall Length—6 1/2" Extends PTO—4-5/16"

OUR BEST SELLER

FOR TRACTORS UP TO 125 PTO H.P.

Clamp Type our price **\$91.07** each

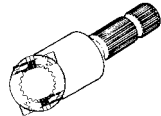

PART #442033201490 1-3/4-6 Spline Male
1-3/4-20 Spline Female
Overall Length—8-3/16" Extends PTO—4-15/16"

PART #442033201491 1-3/4-20 Spline Female x 1-3/8 - 21 Spline Male
Overall Length—8-3/16" Extends PTO—5-7/16"

Clamp Type our price **\$169.95** each

PART #44203320094 1-3/8 - 21 Spline Female
1-3/4 - 20 Spline Male our price **\$138.44** each
Overall Length—7-0" Extends PTO—4-1/2"

HUB CITY OVER-RUNNING COUPLERS UP TO 75 H.P.

CHECK OUR NEW LOWER PRICE

Order #033100660 our price **\$75.65** each
1 3/8" — 6 Female Spline x 1 3/8" — 6 Male Spline

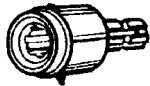

Order #033100670 our price **\$59.95** each
1 1/8" — 6 Female Spline x 1 3/8" — 6 3/4".

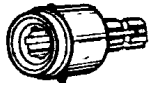

Don't Compromise on Safety!

Avg. Wt. 5 lbs.

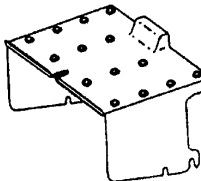

PTO SHIELDS

Part #	Description	Price
AA2297RH	A, B & G	\$56.29
AH1098RH	H-with Large PTO (1-3/8)	84.50
AH821RH	H-with Small PTO (1-1/8)	84.50
AM1020TH	M, MT with Belt Pulley	139.75
AA5243RH	50, Early 60 up to S/N 6025403	87.00
AF1664RH	60 From S/N 6025404 & 70	78.57
AR20482RH	520, 530, 620, 630, 720, 730	64.13
F2519RH	PTO Shield Casting Only Fits 520, 530, 620, 630, 720, 730	84.75
R33348H	Fits JD 2510, 2520, 3020, 4000, 4020, 4030, 4230, 4320, 4430, 4455	38.76
R27562H	Fits JD 3010, 4010, 4520, 4620, 4630, 5010, 5020, 6030, 7030, 7520	39.25
55398DAH	Farmall A, B, C & Supers A, AV, C with Belt Pulley	47.27
55403DAH	Farmall A&B All S/N 18875 & Up C and Supers A, AV, C with out Belt Pulley	63.99
66387DAXAH	Farmall H, HV & Super H Super HV	56.06
66424DBXH	Farmall M, MD Super M, Super MTA	54.05
360181RH	Farmall 300, 330, 340, 350, 400, 450 with Independent PTO	60.00
1264520CH	06-66-86 Series	57.45

Wt. 3 lbs.



PTO Clutch Disc

\$37.95



156086AH	Bonded PTO Clutch Disc	77, Super 77, 88, Super 88, 770, 880,
Sub to 72500239	7.000 O.D. X 1.000 I.D.	1550, 1555, 1600,
Replaces KS1656	12 Spline Hub	1655, IND: 2-62

IH PTO CLUTCH KITS

for all 2 speed IH PTO's

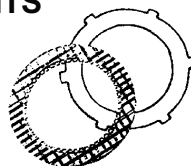
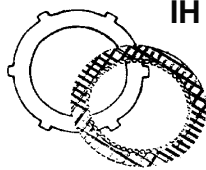

Order #	Description	Wt. 3 lbs.	Application	Our Price
68802CH	5 Fiber, 12 steel		544 Thru 1466	\$58.91
68803CH	7 Fiber, 9 steel		786 Thru 88 Series	\$59.76
Seal, Gasket and Plunger Kit				
77721CH	kit for 68802CH		544 Thru 1466	\$148.65
77720CH	kit for 68803CH		786 Thru 88 Series	\$58.78

MADE USA



Wt. 10 lbs

PTO DRIVE HUBS AND SHAFTS

Make	Order #	Description	Application	Our Price
AC	70255802H	1 3/8x6 spline/1 3/8 x 21	160, 170, 175, 180, 185, 190, XT190 Early 200, 175, 180	\$191.10
AC	70260704H	1 3/8x6 spline/1 3/8x21 spline	Late 175, 180, 185, 200	\$192.27
AC	70266975H	1 3/8x6 spline/1 3/8x21 spline	7010, 7020, 7030, 7040, 7045, 7050, 7060, 8010, 8030, 8050	\$197.83
Case/IH	226824A2H	Reversible 540/1000 RPM	5120, 5220, 5130, 5230, 5140, 5240, 5250	\$103.81
Case	A58214H	1 3/8x6 spline (540)	770, 870, 970, 1070, 1175	\$124.78
Case	A64592H	1 3/8x6 spline (540)	730, 830, 930, 1030	\$236.42
Case	A140655H	1 3/8x6 spline/1 3/8x21 spline	2090, 2290, 2094, 2294	\$108.24
Case	A148833H	1 3/8x21 spline (1000)	Late 1270, 1370, 1570, 2390, 2590, 2394, 2594	\$117.81
Case	A148833SPH	1 3/4x21 spline (1000)	Same as above	\$117.81
JD	AR28572H	1 3/8x6 spline (540)	3010, 4010	\$153.02
JD	AR28573H	1 3/8x21 spline (1000)	3010, 4010	\$139.35
JD	AR41752H	1 3/8x6 spline (540)	2510, 2520, 2840, 3020, 4000, 4020 late, 4320, 4030, 4230, 4430, 4040, 4240, 4440, 4050, 4250, 4450, 4055, 4455	\$130.21
JD	R38224H	1 3/8x21 spline (1000)	Same as above	\$105.78
JD	AR41753H	1 3/8x6 spline (540)	2510, Early 3020, Early 4020	\$126.63
JD	R33342H	1 3/8x21 spline (1000)	Same as above	\$103.54
JD	R41756H	1 3/8x21 spline (1000)	2840, 2940, 2950, 3150	\$133.09
JD	NEW ITEM AT29707H	1 3/8x6 spline (540)	1020, 1520, 2020, 2030	\$166.74
JD	NEW ITEM	1 3/8x6 spline (540)	2440, 2250-2850	
Ford	D8NNN778AAH	PTO DRIVE HUB	8000 Series, 9000 Series, TW10, 20 & 30, TW5, 15, 25, 35, 8530, 8830	\$137.75
Ford	C9NN7A684AH	(From Fly-wheel)	8000 & 9000 Series	\$216.94
Ford	D2NNB728AH	1 3/8x6 spline (540)	5000, 7000 Series, 5600, 5700, 6600, 6700, 8000, 9000	\$126.00
Ford	D2NNB728BH	11.47" long	Same as above	\$137.32
Ford	D2NNN752CH	1 3/8/21 spline (1000)	5000 & 7000 Series, w/single speed PTO	\$115.49
Ford	E4NNN752AAH	1 3/8x6 spline (540)	5000 & 7000 Series, 5600, 5610, 6000, 6610, 7610 & 7710 w/single speed PTO	\$115.93
Ford	E6NNB728AAH	1 3/8x6 spline (540)	5610, 6610, 7610, 7710 late, 7910, 8210, TW5, 15, 25, 8530, 8830, 5640, 7740, 7840, 8340	\$130.36
Ford	D8NNB728BCH	w/dual speed	Same as above	\$141.09
Ford	D8NNB728CCH	1 3/8x21 spline (1000)	Same as above	\$174.00
IH	120985CH	(1000 RPM)	aLL 06, 66, 86 W/DUAL SPEED pto	\$245.94
IH	393111RH	(540 RPM)	Same as above w/dual speed PTO	\$101.38
IH	148663CH	NEW ITEM	5088, 5288, 7110, 7120	\$140.22
MF	736954MH	PTO DRIVE HUB	1100, 1130	\$242.73
MF	740635MH	PTO DRIVE HUB	1105, 1135, 1150	\$141.74
MF	503433MH	w/12 BOLTS	1100, 1130, 1150, 1105, 1135, 1155	\$144.93
MF	528009MH	11.57x17 spline x 21 spline	1105, 1135, 1155	\$183.70
MF	677496H	33.06" long & 17 spline	1105, 1135	\$136.95
MF	509695MH	shaft/mount flange 4 bolt holes	1100, 1105, 1130, 1135, 1150	\$195.87
MF	NEW ITEM 1610238MH	1 3/8x6 spline (540)		\$197.36
MF	NEW ITEM	1 3/8x6 spline (540)	2705, 2745, 2675, 2805, 2775	
Oliver	303068277H	PTO DRIVE HUB	77, 88, 770, 880, 1600, 1550, 1555, 1650, 1655, 2-62, 2-78, 4-78	\$139.64
Oliver	163463AH	12 internal spline	1750, 1775, 1850, 1855, 1950	\$250.13
Oliver	303075338H	67 1/8" long 17 spline	2255, white 2150, 1870 & 2270	\$259.70
Oliver	164103AH	68 3/8" long 17 spline	1750, 1755, 1850g, 1855, 1950T, 1955	\$206.12
White	164812AH	PTO DRIVE HUB	17 spline, 5 hole	\$147.95
White	158281AH	PTO DRIVE HUB	17 spline 6 hole	\$95.95
White	167698AH	1 3/8x6 spline	1750, 1755, 1850, 1855, 2255, 2-85-280, 2-105, 2-110, 2-150	\$95.95
White		1 3/8x21 spline	Same as above	\$85.41

4-14
HYDRAULIC/
DRIVETRAIN